

# PROJECT BENEFIT SZD2 060 U140



U140

X: 0 mm

Y: 0 mm

Z: 0 mm



X: 580 mm

Y: 372 mm

Z: 560 mm

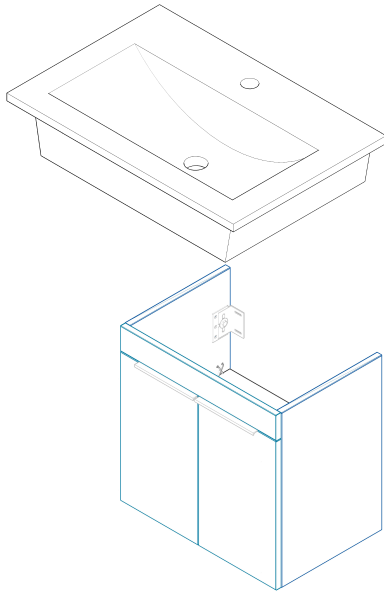

A



- A 570 mm
- B 620 mm
- C 80-120 mm
- D 290 mm
- E ... mm
- F ... mm
- G 683 mm
- H ... mm
- I ... mm
- J 860 mm
- M mm
- N mm

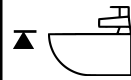
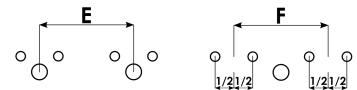
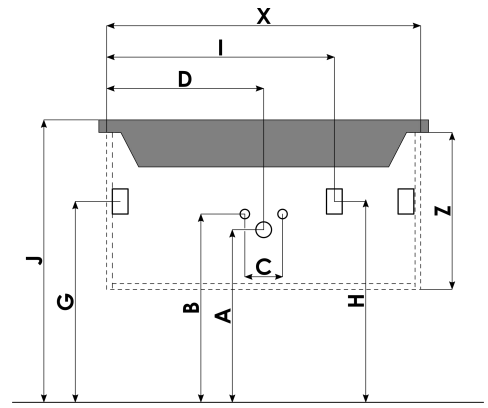

J Art.No ...

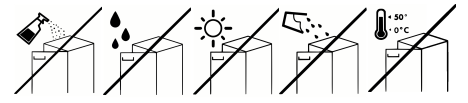

A

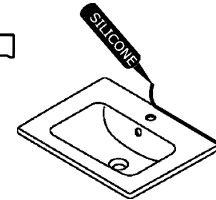
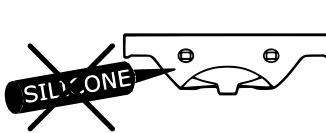
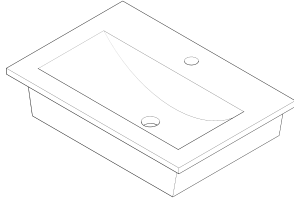

B

